

4" Unterwasserpumpen



Hauptmerkmale

- Montage auf FRANKLIN-Motoren
- geringe axiale Belastung der Welle, daher hohe Lebensdauer des Motors
- Arbeitsdruck bis 26 bar
- durch stark dimensionierte Bauteile ist auch der Einsatz unter härtesten Bedingungen möglich
- geringe Anteile von Feststoffen im Wasser sind zulässig (50ppm)
- Gehäuse aus CrNi-Stahl 1.4301
- für Dauerbetrieb geeignet
- mit integriertem Rückschlagventil

Einsatzgebiete

- Wasserversorgung für Haushalt und Industrie
- Druckerhöhungsanlagen
- kleine und mittlere Feuerlöschsysteme
- Bewässerungsanlagen, Garten- und Landschaftsbau
- Betrieb von Springbrunnen
- für Brunnen mit mind. 4" und einer Druckhöhe von max. 260 m
- für vertikalen Einbau vorgesehen
- Zubehör für horizontalen Einbau lieferbar

Technische Merkmale

- **Förderdaten**

Fördermedium	klares Wasser
Temperatur	max. 40°C
Eintauchtiefe	max. 150 m
- **Konstruktion**

Lauftrad	geschlossen
Lagerung	radiale und axiale Rillenkugellager
- **Werkstoffe**

Gehäuse	CrNi-Stahl 1.4301
Pumpenwelle	CrNi-Stahl 1.4301
Ansauggitter	CrNi-Stahl 1.4301
Motoraufnahme	CrNi-Stahl 1.4301
Pumpenkopf	CrNi-Stahl 1.4301
Lauftrad	Techno-Polymer
Leitrad	Techno-Polymer
O-Ringe	NBR
- **Motor**

Schutzart	IP 58
Isolationsklasse	B
	2-polig
- **Spannung**

Wechselstromausführung:	mit 230 V Motor und Kurzkabel
Drehstromausführung:	mit 400 V Motor und Kurzkabel (1,5 m bis 1,5 kW / 2,5 m ab 2,2 kW) (Motorschutz bauseits)
- **Anschlussmaß**

A1, B2, C4, und C5	G 1¼" IG
D9 und E15	G 2" IG

Typenschlüssel

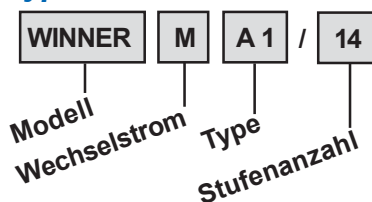

4“ Unterwasserpumpen

Pumpentype		kW	Kondensator µF	Stromaufnahme A	
1~230 V / 50 Hz	3~400 V / 50 Hz			1~230 V	3~400 V
WINNER M A1/14	WINNER A1/14	0,37	16,0	3,3	1,1
WINNER M A1/21	WINNER A1/21	0,55	20,0	5,1	1,6
WINNER M A1/28	WINNER A1/28	0,75	30,0	6,0	2,1
WINNER M B2/7	WINNER B2/7	0,37	16,0	3,3	1,1
WINNER M B2/10	WINNER B2/10	0,55	20,0	5,1	1,6
WINNER M B2/14	WINNER B2/14	0,75	30,0	6,0	2,1
WINNER M B2/21	WINNER B2/21	1,10	40,0	8,7	3,0
WINNER M B2/28	WINNER B2/28	1,50	60,0	11,2	4,0
WINNER M B2/40	WINNER B2/40	2,20	80,0	16,7	5,9
WINNER M C4/4	WINNER C4/4	0,37	16,0	3,3	1,1
WINNER M C4/6	WINNER C4/6	0,55	20,0	5,1	1,6
WINNER M C4/9	WINNER C4/9	0,75	30,0	6,0	2,1
WINNER M C4/13	WINNER C4/13	1,10	40,0	8,7	3,0
WINNER M C4/18	WINNER C4/18	1,50	60,0	11,2	4,0
WINNER M C4/27	WINNER C4/27	2,20	80,0	16,7	5,9
WINNER M C5/7	WINNER C5/7	0,75	30,0	6,0	2,1
WINNER M C5/10	WINNER C5/10	1,10	40,0	8,7	3,0
WINNER M C5/14	WINNER C5/14	1,50	60,0	11,2	4,0
WINNER M C5/21	WINNER C5/21	2,20	80,0	16,7	5,9
-	WINNER C5/28	3,00	-	-	7,8
-	WINNER C5/38	4,00	-	-	10,0
WINNER M D9/4	WINNER D9/4	0,55	20,0	5,1	1,6
WINNER M D9/5	WINNER D9/5	0,75	30,0	6,0	2,1
WINNER M D9/7	WINNER D9/7	1,10	40,0	8,7	3,0
WINNER M D9/9	WINNER D9/9	1,50	60,0	11,2	4,0
WINNER M D9/14	WINNER D9/14	2,20	80,0	16,7	5,9
-	WINNER D9/19	3,00	-	-	7,8
-	WINNER D9/26	4,00	-	-	10,0
WINNER M E15/4	WINNER E15/4	1,10	40,0	8,7	3,0
WINNER M E15/6	WINNER E15/6	1,50	60,0	11,2	4,0
WINNER M E15/9	WINNER E15/9	2,20	80,0	16,7	5,9
-	WINNER E15/12	3,00	-	-	7,8
-	WINNER E15/16	4,00	-	-	10,0
-	WINNER E15/22	5,50	-	-	13,7

Einbauschema bei horizontalem Betrieb der Pumpe

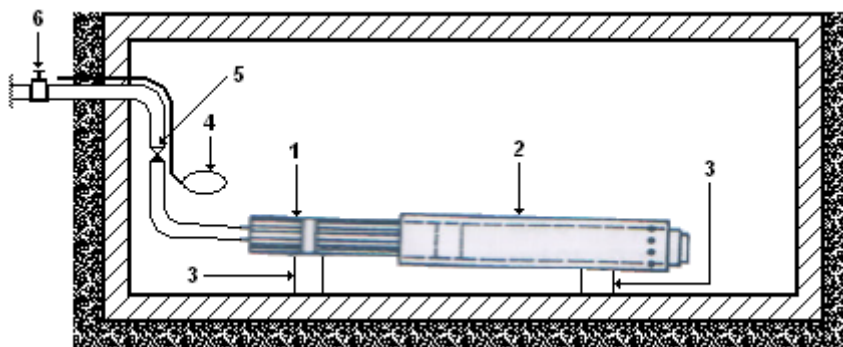

1. Pumpe
2. Kühlmantel
3. Lagerböcke
4. Schwimmerschalter als Trockenlaufschutz
5. Rückflußverhinderer
6. Absperrschieber

4" Unterwasserpumpen

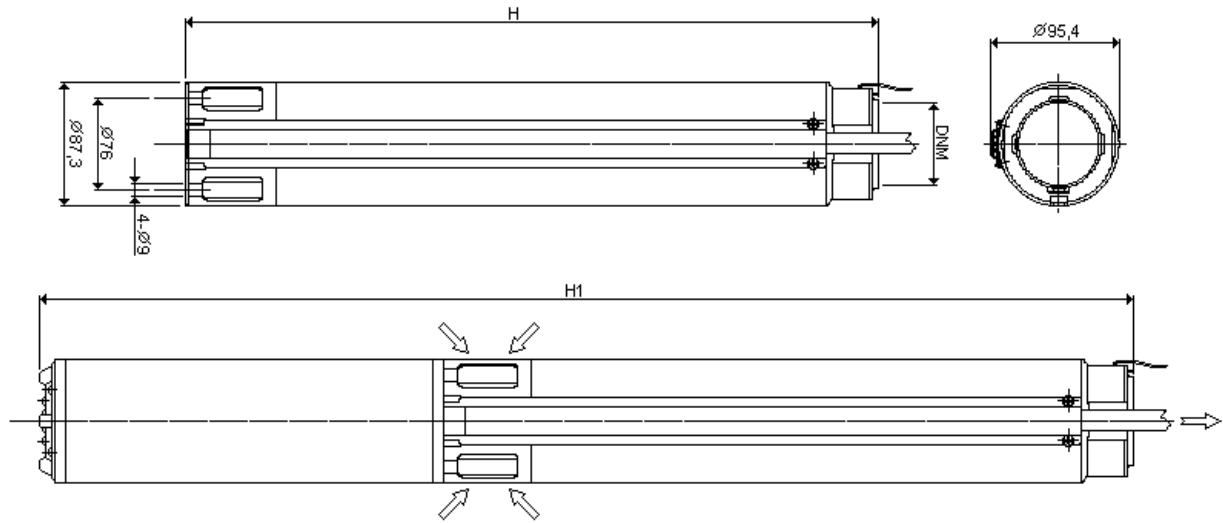

Pumpentype		Dimensionen (mm)				Gewicht	
1~230 V / 50 Hz	3~400 V / 50 Hz	H	H1		DNM	kg	
			1~	3~		1~	3~
WINNER M A 1/14	WINNER A 1/14	588,5	860,0	845,0	G 1 1/4	13,9	13,3
WINNER M A 1/21	WINNER A 1/21	736,0	1032,5	1007,5	G 1 1/4	16,7	15,7
WINNER M A 1/28	WINNER A 1/28	941,0	1272,5	1237,5	G 1 1/4	21,2	19,6
WINNER M B 2/7	WINNER B 2/7	401,0	672,5	657,5	G 1 1/4	12,2	11,6
WINNER M B 2/10	WINNER B 2/10	473,0	769,5	744,5	G 1 1/4	14,1	13,1
WINNER M B 2/14	WINNER B 2/14	568,5	900,0	865,0	G 1 1/4	17,0	15,4
WINNER M B 2/21	WINNER B 2/21	736,0	1102,5	1067,5	G 1 1/4	20,2	18,8
WINNER M B 2/28	WINNER B 2/28	941,0	1357,5	1307,5	G 1 1/4	25,2	23,0
WINNER M B 2/40	WINNER B 2/40	1228,0	1704,5	1644,5	G 1 1/4	31,5	28,8
WINNER M C 4/4	WINNER C 4/4	337,5	609,0	594,0	G 1 1/4	11,3	10,7
WINNER M C 4/6	WINNER C 4/6	389,5	686,0	661,0	G 1 1/4	13,0	12,0
WINNER M C 4/9	WINNER C 4/9	467,0	798,5	763,5	G 1 1/4	15,7	14,1
WINNER M C 4/13	WINNER C 4/13	570,5	937,0	902,0	G 1 1/4	18,1	16,7
WINNER M C 4/18	WINNER C 4/18	700,0	1116,5	1066,5	G 1 1/4	21,8	19,6
WINNER M C 4/27	WINNER C 4/27	971,0	1447,5	1387,5	G 1 1/4	27,5	24,8
WINNER M C 5/7	WINNER C 5/7	513,5	845,0	810,0	G 1 1/4	15,2	13,6
WINNER M C 5/10	WINNER C 5/10	633,0	999,5	964,5	G 1 1/4	17,6	16,2
WINNER M C 5/14	WINNER C 5/14	793,0	1209,5	1159,5	G 1 1/4	21,1	18,9
WINNER M C 5/21	WINNER C 5/21	1110,0	1586,5	1526,5	G 1 1/4	25,5	22,8
-	WINNER C 5/28	1389,5	-	1891,0	G 1 1/4	-	30,9
-	WINNER C 5/38	1788,5	-	2360,0	G 1 1/4	-	37,5
WINNER M D 9/4	WINNER D 9/4	417,5	714,0	689,0	G 2	13,1	12,1
WINNER M D 9/5	WINNER D 9/5	463,5	795,0	760,0	G 2	15,2	13,6
WINNER M D 9/7	WINNER D 9/7	555,0	921,5	886,5	G 2	17,6	16,2
WINNER M D 9/9	WINNER D 9/9	647,0	1063,5	1013,5	G 2	21,1	18,9
WINNER M D 9/14	WINNER D 9/14	876,5	1353,0	1293,0	G 2	26,0	23,3
-	WINNER D 9/19	1144,0	-	1645,5	G 2	-	31,0
-	WINNER D 9/26	1465,5	-	2037,0	G 2	-	37,0
WINNER M E 15/4	WINNER E 15/4	539,0	905,5	870,5	G 2	17,6	16,2
WINNER M E 15/6	WINNER E 15/6	730,0	1146,5	1069,5	G 2	21,9	19,7
WINNER M E 15/9	WINNER E 15/9	997,5	1474,0	1414,0	G 2	28,5	25,8
-	WINNER E 15/12	1265,0	-	1766,5	G 2	-	35,0
-	WINNER E 15/16	1571,0	-	2142,5	G 2	-	39,5
-	WINNER E 15/22	2068,0	-	2749,5	G 2	-	48,5

4" Unterwasserpumpen

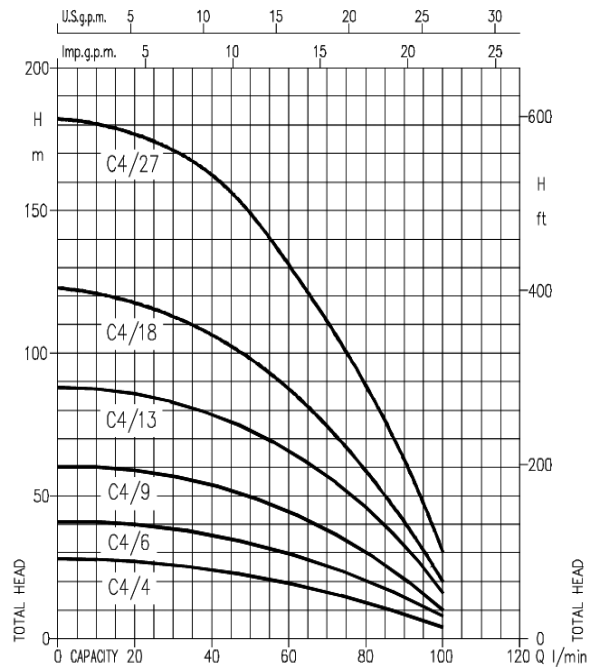
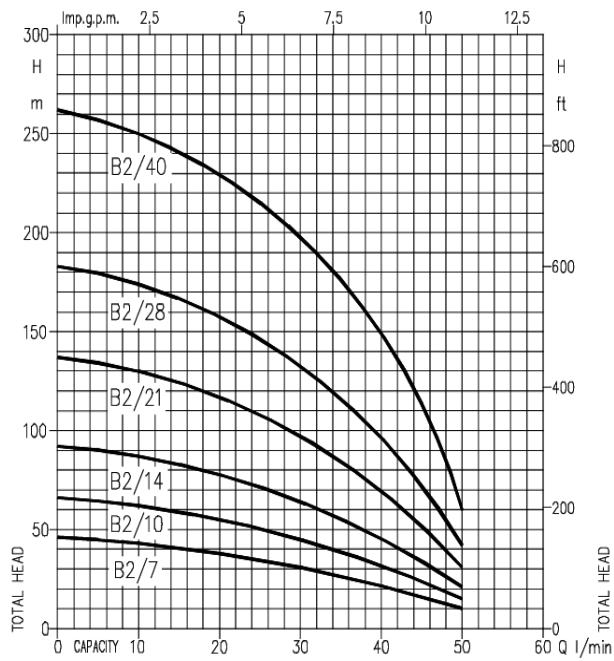
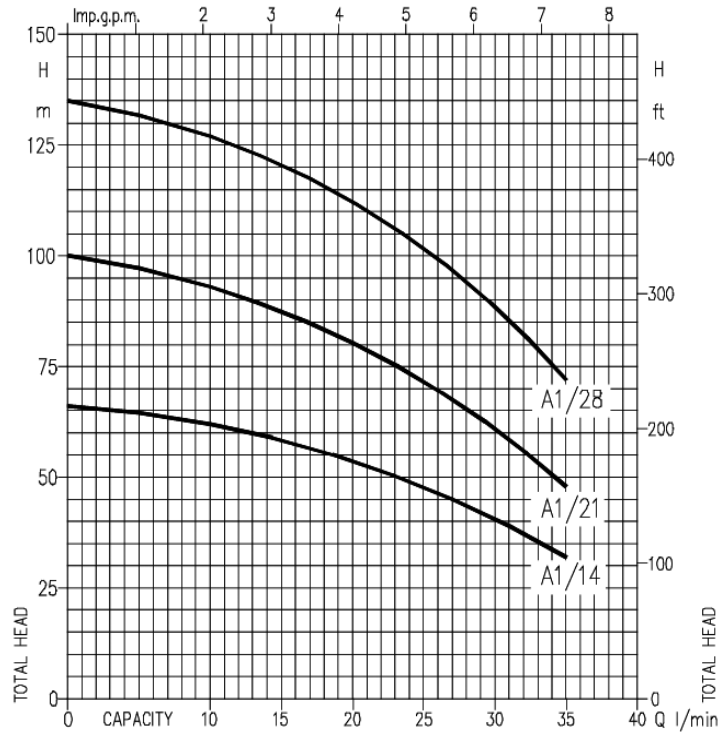

WINNER

4" Unterwasserpumpen

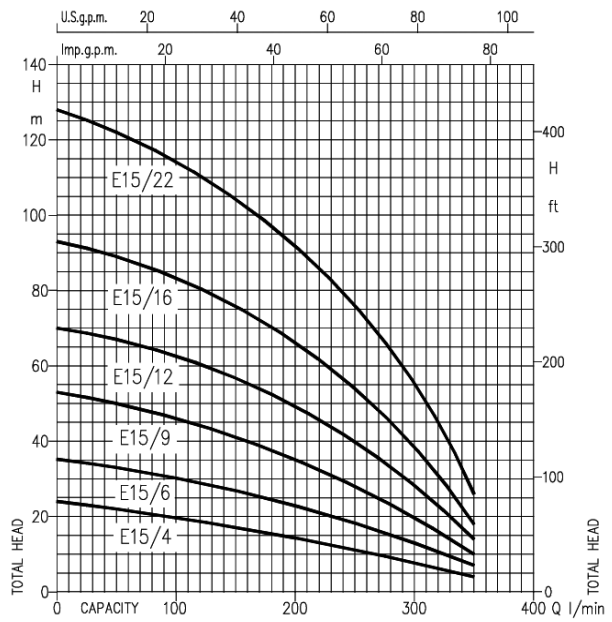
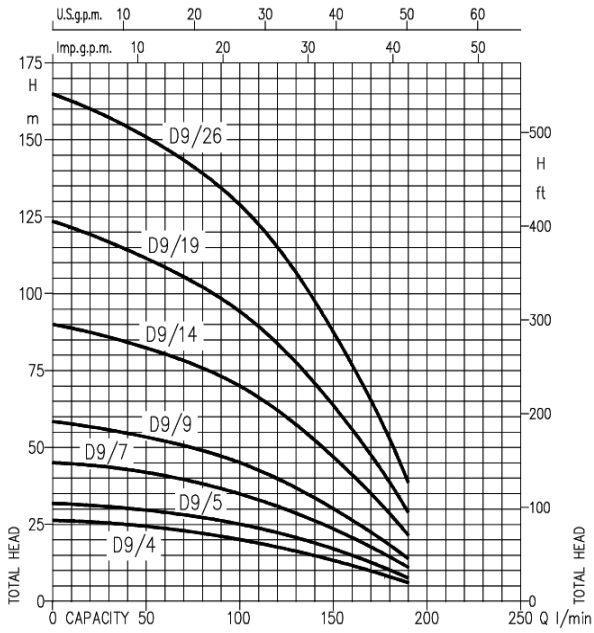
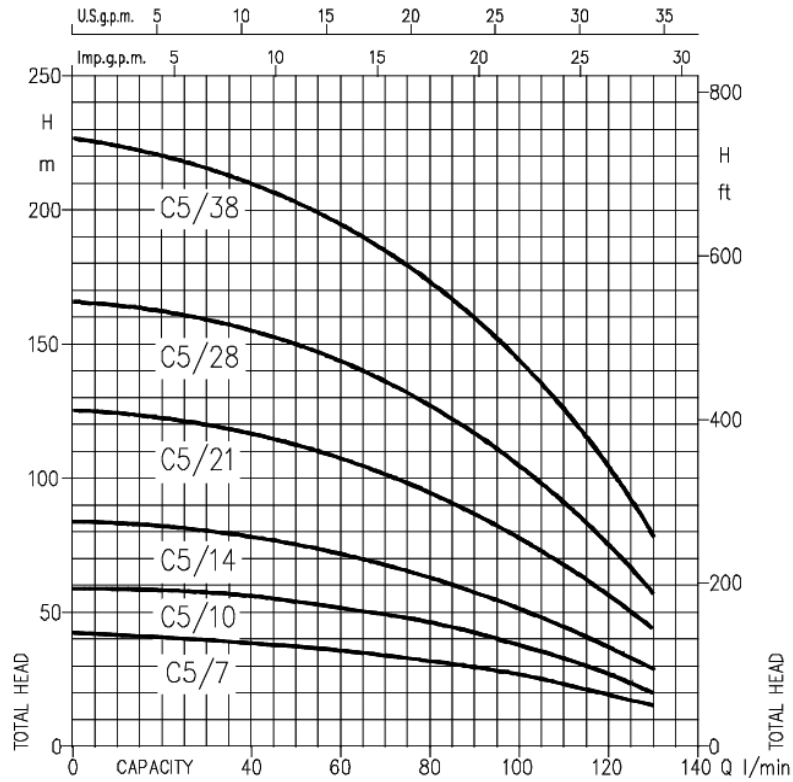

4“ Unterwasserpumpen

Pumpentype		Artikel Nr.	Preis	Artikel Nr.	Preis
1~230 V / 50 Hz	3~400 V / 50 Hz	1~230 V / 50 Hz	€	3~400 V / 50 Hz	€
WINNER M A1/14	WINNER A1/14	U 1502534114		U 1503534114	
WINNER M A1/21	WINNER A1/21	U 1502534121		U 1503534121	
WINNER M A1/28	WINNER A1/28	U 1502534128		U 1503534128	
WINNER M B2/7	WINNER B2/7	U 1512534507		U 1513534507	
WINNER M B2/10	WINNER B2/10	U 1512534510		U 1513534510	
WINNER M B2/14	WINNER B2/14	U 1512534514		U 1513534514	
WINNER M B2/21	WINNER B2/21	U 1512534521		U 1513534521	
WINNER M B2/28	WINNER B2/28	U 1512534528		U 1513534528	
WINNER M B2/40	WINNER B2/40	U 1512534540		U 1513534540	
WINNER M C4/4	WINNER C4/4	U 1522534404		U 1523534404	
WINNER M C4/6	WINNER C4/6	U 1522534406		U 1523534406	
WINNER M C4/9	WINNER C4/9	U 1522534409		U 1523534409	
WINNER M C4/13	WINNER C4/13	U 1522534413		U 1523534413	
WINNER M C4/18	WINNER C4/18	U 1522534418		U 1523534418	
WINNER M C4/27	WINNER C4/27	U 1522534427		U 1523534427	
WINNER M C5/7	WINNER C5/7	U 1522534207		U 1523534207	
WINNER M C5/10	WINNER C5/10	U 1522534210		U 1523534210	
WINNER M C5/14	WINNER C5/14	U 1522534214		U 1523534214	
WINNER M C5/21	WINNER C5/21	U 1522534221		U 1523534221	
-	WINNER C5/28	-	-	U 1533534228	
-	WINNER C5/38	-	-	U 1533534238	
WINNER M D9/4	WINNER D9/4	U 1532534604		U 1533534604	
WINNER M D9/5	WINNER D9/5	U 1532534605		U 1533534605	
WINNER M D9/7	WINNER D9/7	U 1532534607		U 1533534607	
WINNER M D9/9	WINNER D9/9	U 1532534609		U 1533534609	
WINNER M D9/14	WINNER D9/14	U 1532534614		U 1533534614	
-	WINNER D9/19	-	-	U 1533534619	
-	WINNER D9/26	-	-	U 1533534626	
WINNER M E15/4	WINNER E15/4	U 1542535004		U 1543535004	
WINNER M E15/6	WINNER E15/6	U 1542535006		U 1543535006	
WINNER M E15/9	WINNER E15/9	U 1542535009		U 1543535009	
-	WINNER E15/12	-	-	U 1543534626	
-	WINNER E15/16	-	-	U 1553535016	
-	WINNER E15/22	-	-	U 1553535022	

Zubehör:

Bezeichnung	Artikel Nr.	Preis €
Kühlmantel Edelstahl	U 5100009100	
Lagerböcke Edelstahl (2 Stück)	U 5100010100	
Niro-Stahlseil 7 x 7, d: 2 mm, Mindestbruchkraft 2256	U 400002	
Bügelseilklemmen Edelstahl, 2 mm	U 400102050	
Kabelverbinder GT 110.001	U 459690	
Trinkwasserkabel 4 x 1,5 mm	U 12834	
Trinkwasserkabel 4 x 2,5 mm	U 12838	
Trinkwasserkabel 4 x 4 mm	U 12842	